

PRODUCT SHEET  
REV 0.0 - IT202504  
**6888 PRINCE  
HUBERT**

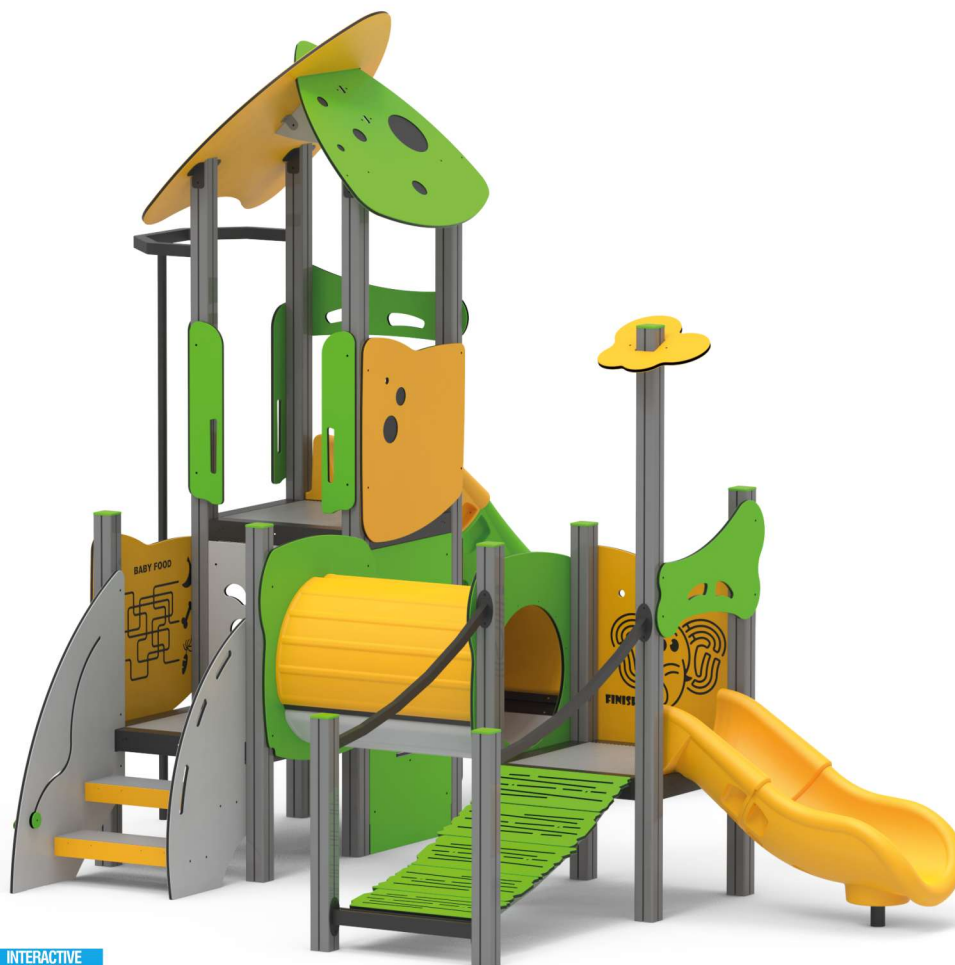





ORGANIZATION WITH QUALITY MANAGEMENT SYSTEM  
ISO 9001:2015 CERTIFIED by  
EuCI European Certification Institute LTD  
Certificate N.: GOTT2532Q1902

ORGANIZATION WITH ENVIRONMENTAL MANAGEMENT SYSTEM  
ISO 14001:2015 CERTIFIED by  
EuCI European Certification Institute LTD  
Certificate No: GOTT2532E1801



SECURITY AREA

800

	CATALOG COLLECTION	PARTY LINE
	<b>DIMENSIONS (L x W x H) in cm</b>	480 x 440 x 360 cm
	<b>IMPACT AREA</b>	39,00 m <sup>2</sup>
	<b>MAXIMUM CFH</b>	140 cm
	<b>SUGGESTED AGE OF USE</b>	3+
	<b>NUMBER OF USERS</b>	12

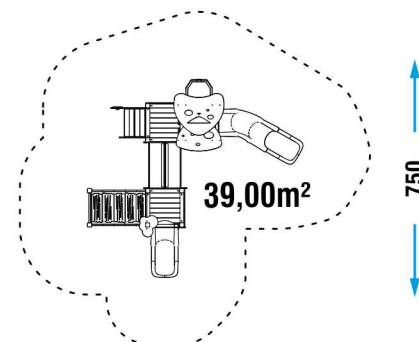

PRODUCT SHEET  
REV 0.0 - IT202504  
**6888 PRINCE  
HUBERT**

**COMPOSITION**

- n° 12 90x90 mm square section aluminum structural posts
- n° 3 decks with powder-coated metal frame and aluminum slats
- n° 1 HDPE sheet roof
- n° 1 fireman's post
- n° 3 HDPE sheet guard panels
- n° 1 roto-molded PTE tunnel
- n° 2 HDPE sheet thrust bearing
- n° 1 roto-molded PTE modular slide (H60)
- n° 1 roto-molded PTE modular slide (H140)
- n° 1 HDPE sheet decoration
- n° 1 HDPE sheet bench
- n° 1 «PASSERELLA» bridge

**PLAY PANELS**



**LUDIC PLAY PANEL  
x1**

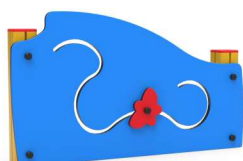

**LUDIC PLAY PANEL  
x1**



**EDUCATIONAL PLAY PANEL  
x1**

**INSTALLATION**

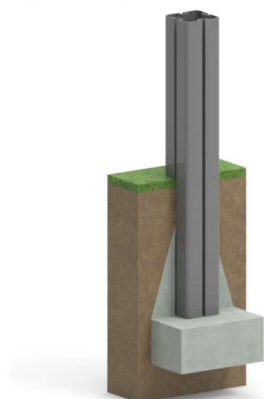

Where there is an aluminum pole, the plinth must be created directly on it.



If there is already an adequate fund in CLS the game can be supplied with special brackets for fixing to the ground (option applicable only with confirmation of feasibility).

Make a proper security surface according to CFH. Periodic maintenance is mandatory, following manual supplied to customer.

MATERIALE (mm) MATERIAL (mm)	DESCRIZIONE (mm) DESCRIPTION (mm)	PROFONDITÀ MINIMA (mm) (b) MINIMUM DEPTH (mm) (b)	ALTEZZA MASSIMA DI CADUTA (mm) CRITICAL FALL HEIGHT (mm)
PRATO/TERRICCIO LAWN/SOIL			1000 (d)
CORTECCIA BARK	PEZZATURA DA 20 A 80 20 TO 80 GRAIN SIZE	200	2000
		300	3000
TRUCIOLI DI LEGNO WOOD CHIPS	PEZZATURA DA 20 A 80 20 TO 80 GRAIN SIZE	200	2000
		300	3000
SABBIA SAND	PEZZATURA DA 20 A 80 20 TO 80 GRAIN SIZE	200	2000
		300	3000
GHIAIA GRAVEL	PEZZATURA DA 20 A 80 20 TO 80 GRAIN SIZE	200	2000
		300	3000
PAVIMENTAZIONE IN GOMMA RISPONDENTE A HIC RUBBER SURFACING RESPONDENT TO HIC	SPESSORE/THICKNESS	30mm	1000
		40mm	1300
		45mm	1500
		60mm	2000
		70mm	2500
		90mm	3000
			SOTTOPOSTA A PROVE DI CADUTA DEPENDENT ON CERTIFICATION TESTS